



Tel:- 01179 824824
sales@kingshaulage.co.uk

90t Low Loader



- Extending lower bed 8m – 23.75m
- Bed Height 0.450m Rear Deck Height 1.1m
- Bed Width 2.74m – 3.240m
- Hydraulic raise and lower at both ends
- Rear Steer - Auto or manual
- 95 ton capacity
- Front or rear loading
- Bed sections removable

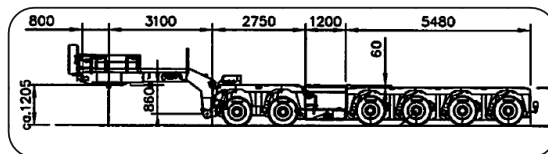
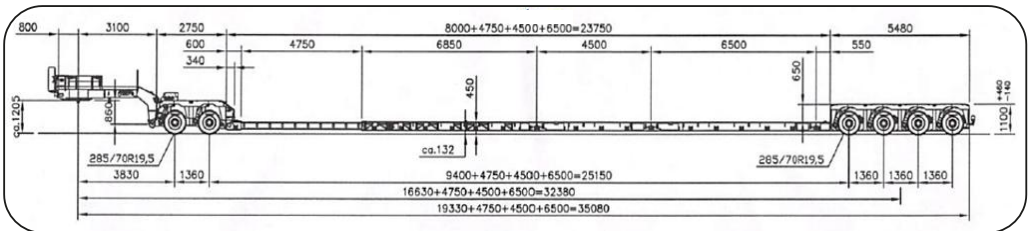

80 Ton Low Loader – 3 available



- Extending bed 8.5m – 14.25m
- Bed Height 0.575m Rear Deck Height 0.975m
- Bed Width 2.74m – 3.24m
- Hydraulic raise and lower at both ends
- Rear Steer - Auto or manual
- 80 ton capacity
- Front or rear loading

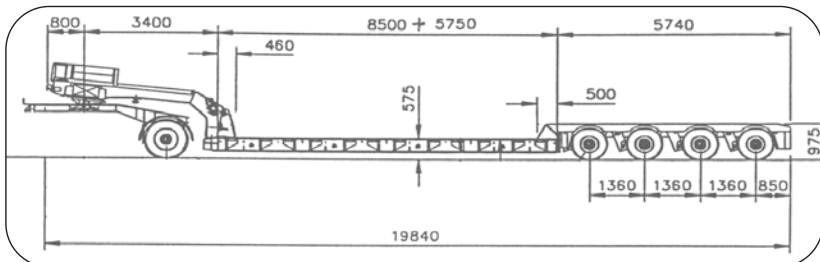

5 Axle Steering Semi Low Loader



- 63 Ton capacity
- 2.75m Bed Width
- 1.08m Bed Height
- Hydraulic Raise / Lower
- Extending Deck 10m – 32m
- Outriggers
- Removable Ramps
- Remote / Auto steering

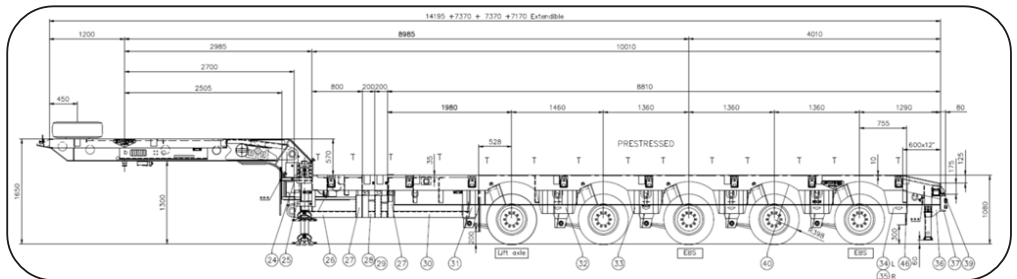

4 Axle Steering Semi Low Loaders

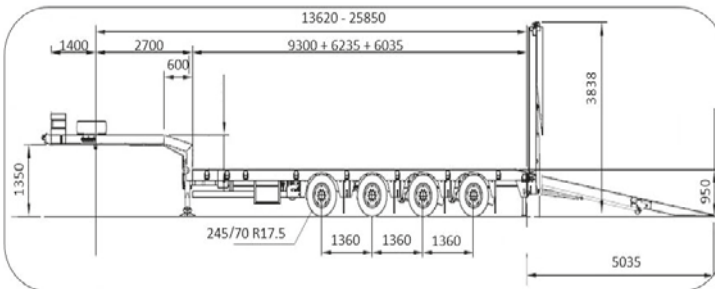

- 55 Ton capacity
- 0.9m Bed Height
- Air raise/lower
- 2.55m Bed Width
- 2.9m Bed Width
- Extending Deck
- Twistlocks
- Removable Ramps
- 5 in the fleet

3 Axle Steering Semi Low Loaders



- 35 Ton capacity
- 0.9m Bed Height
- Air raise/lower
- 2.52m -3.02m Bed Width
- Extending Deck 8.93m – 15.63m
- Twistlocks
- Removable Ramps
- Full rear steering remote or auto.

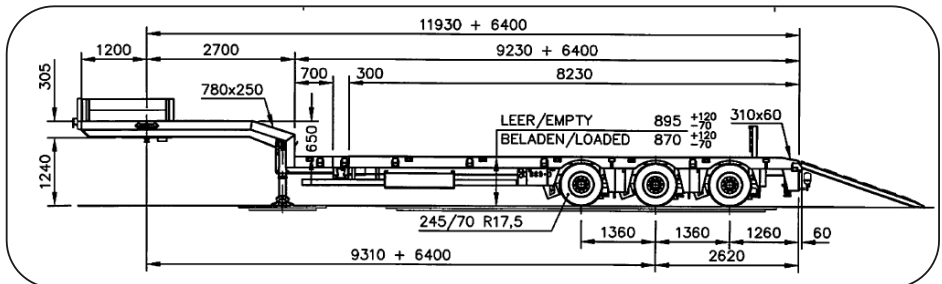

5 x Extending Flats with Steering

- Full Steering – Auto or Manual
- 13.6m Closed Length
- 36m Extended Length
- 2.5m Bed Width
- Approx 1.5m Bed Height
- Multi Position Twistlocks
- 55 Ton capacity (4 Axle Version)
- Max load height in UK 3.0m



13.6m Flat / PSK



- 13.6m (45') Bed Length
- 2.5m (8'2) Bed Width
- Approx 1.5m (5') Bed Height
- Multi position Twistlocks
- Removable Headboard
- 27 Ton capacity
- Max load height in UK 3.2m

ADR Type Tractor Units



ADR Tractor Units for the carriage of Dangerous Goods.

- Class 2 – Gases
- Class 3 – Flammable liquids
- Class 4 – Spontaneous substances
- Class 5 – Oxidizing substances and Organic peroxides
- Class 6 – Toxic & Infectious substances
- Class 7 – Radioactive Equipment
- Class 8 - Corrosive substances
- Class 9 – Miscellaneous substances

13.6m Euroliner

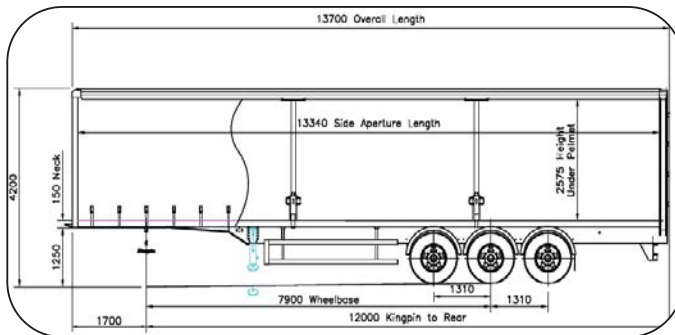

- Opening Roof
- Opening sides
- 26 Ton Payload
- Air raise/lower
- 4m Overall Height for continental use
- 4.5m Height for UK use
- 26 Pallet capacity
- ADR type II

Self Loader - Tractor Unit



Remote Control

360° Slew

6 Leg Stability

Truck mounted
6 X 4
Heavy Haulage
Unit

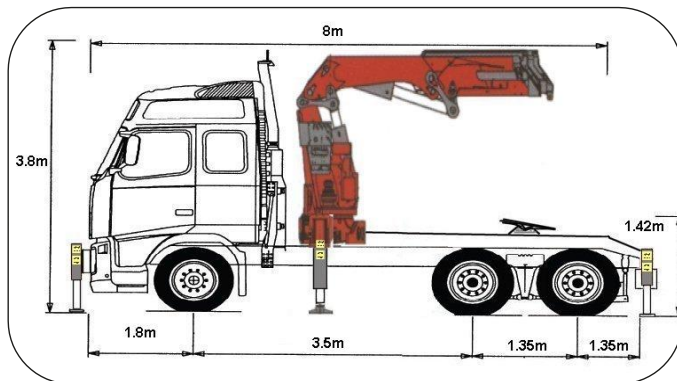

Palfinger 76 Ton/Meter Self Loader

Outreach	Capacity
4.3m	15,400kg
5.9m	10,900kg
7.7m	8,200kg
9.6m	6,400kg
11.6m	5,200kg
13.7m	4,300kg
15.8m	3,700kg

Self Loader - Rigid Unit



Remote Control

360° Slew

Air Suspension

With/Without
Rear Ramps

With/Without
Trailer

Palfinger PK62002 EH E Lifting Duties

Lift Radius - Metres	4.2	5.9	7.7	9.6	11.7	13.9	16.1
Lift Capacity - KG	11300	7900	5900	4600	3750	3100	2650

Large Panel Van



Double locked for movement of Section 5 Goods / EXII / ADR

Payload 1455kg

Compartment size 4.3m x 1.75m x 1.8m (1.29m wheel arches)

Escort Vehicles



Warehouse Indoor and Outdoor Storage



Hiab vehicles

Hiab vehicles capable of lifting up to approx.10 tonnes are available with flatbed (20' or 40'), semi low loader or low loader options.

Low loaders

Large range of Steering, Extending low loaders available with maximum pay load of 95 tonnes.

Semi Low loaders

Semi low loaders are available either with or without loading ramps with maximum payload of 65 tonnes.

Flatbeds + Curtainsiders

Side protection system available on flatbeds . Our curtainsiders and flatbeds are regularly engaged in general haulage operations in both the UK and Europe.

Extendible Trailers

Our extendible trailers are regularly used to carry loads up to 39.95m long, and are available with rear wheel steering.

Dangerous / Hazardous Goods / Section 5

We hold all the relevant licences and equipment to deal with goods including chemicals, waste, explosives and prohibited weapons.

Our operatives are certified in ADR and Level CO Aviation Security.

Abnormal Loads

Loads of an abnormal nature in length, width, height or weight are our speciality. We can survey site access, notify the route to relevant authorities and carry out the task professionally.

Europe

We regularly undertake movements of both normal and abnormal loads to and from European destinations.

Express Van Service

This service is available for smaller cargos, utilising a range of vans which are ADR / EXII compliant. Destinations in the UK and Europe

Vehicle and Trailer Hire

A selection of vehicles and trailers are available to hire.

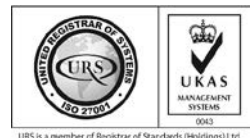



Kings Heavy Haulage, Third Way, Avonmouth, Bristol, BS11 9YS.

sales@kingshaulage.co.uk

Tel:- 0117 9824824 Web:- www.Kingshaulage.co.uk